

Rev: (0) April 17 2013

**FEIYU**  
**TECH**

# **FY-41AP AUTOPILOT SYSTEM**

Airplane flight stabilization & Autopilot System  
Installation & Operation Guide



**Guilin Feiyu Electronic Technology Co., Ltd**

4th Floor, Yu Tai Jie Science&technology Building, Information Industry Park, Chaoyang Road,  
Qixing District, GuiLin, CN

[www.feiyudz.cn](http://www.feiyudz.cn)

Email: [service@feiyu-tech.com](mailto:service@feiyu-tech.com)

## **FY41AP INSTALLATION AND OPERATION GUIDE**

FY-41AP Flight Modes .....	5
FY-41AP Standard Configuration .....	6
Optional Accessory .....	6
FY41AP Specification & Working Requirement .....	7
The FY-41AP Aircraft Configuration Options .....	7
The FY-41AP RC System Compatibility .....	7
FY-41AP Connection Interface.....	8
VIEW A Interface Diagram: .....	8
VIEW B Interface Diagram .....	9
Connecting The FY41AP To The RC Receiver.....	10
Plane Servo Connection (Refer VIEW A) .....	13
Integrated Current Sensor / Power Manager .....	14
Gps Installation And Requirements.....	16
FY41AP Connection Summary.....	17
FY-41AP LED Instruction .....	18
Vibration Damping .....	19
Checking For Vibration Levels.....	20
In-Flight Symptoms Of Too Much Vibration .....	20
Switch Channel Setting.....	21
SW2 Default Setting State .....	21
FY-41AP Installation Orientation .....	22
FY-41AP Installation Position .....	23
setting Correct Servo Direction .....	24
auto Balance Mode (Abm) Servo Movement Check & Setting.....	24
Gyroscope Reset.....	27
FY-41AP SETTING SOFTWARE.....	28
Changing Stabilization Gain:.....	30
Configuration Function.....	30
Install Setting .....	32
Mix Setting .....	33
'Switch Mode' Sw-2 Function Setting .....	34
Reverse - Reversing Servo In Stabilized Mode .....	35

Circling Radius Setting .....	35
Dialog Box .....	35
Max Distance Setting.....	36
Cruising Speed Setting .....	36
Air Speed Sensor .....	36
FY-41AP FIRST FLIGHT TEST CHECKLIST .....	39
Data Radio & Gcs Software .....	40
Warning: Pilot Input And Autonomous Flight Interaction.....	42
Fail-Safe And Autonomous Return To Launch .....	43
FY-41AP-OSD INSTRUCTIONS .....	44
FY-41AP-OSD Display Interface.....	45
Adjusting FY41AP Setting Via OSD .....	46
OSD Menu Interface.....	47

## MANUAL REVISION SUMMARY

REVISION	Rev. Date	Update Note
0	16 April 2013	New Manual Release



## **FY-41AP Flight Stabilization System**

### **Installation & Operation Manual**

#### **Dear Customer :**

Thank you for choosing FY-41AP as your autopilot system. Please read this manual carefully to ensure correct installation & operation.

- **If you are a complete beginner & have never flown one before, we do not recommend you install this device on your own.** Please find an experienced RC pilot who may provide you with the basic knowledge required to use this device successfully.
- If you are already an experienced flyer, you will find the FY-41AP installation to be easy & logical. Follow this manual & you won't go wrong.

If you need further technical support, contact us at: [service@feiyu-tech.com](mailto:service@feiyu-tech.com)

#### **FY41AP - overview :**

- a) FY-41AP is an inertial attitude stabilizer for fixed-wing & multicopter aircraft.
- b) The FY41AP has an on screen display (OSD) hardware already integrated into the module, making installation for FPV simple, light and compact. Critical flight information is displayed via your existing downlink system.
- c) Flight stabilization is achieved via an integrated 3 axis gyro, 3 axis accelerometer, 3 axis magnetometer and a barometric pressure sensor. This enables the module to accurately measure flight attitude, earth azimuth & relative altitude to achieve:
  - Extremely stable conventional flight pattern
  - Stabilized 3D flight
  - Automatically return to home (RTL)
  - Fixed altitude flight
  - Heading lock flight
  - GPS waypoint flight
  - Auto circling over a fixed GPS location.







- d) **GPS Data** – enables the FY-41AP to calculate the flight course & sense the exact location of the aircraft. GPS Data allows aircraft return to home (RTL), Auto Circle, Fixed altitude, Heading lock flight and fully autonomous flight via GPS waypoints setting.
  
- e) **Airspeed sensor** – enables the system to automatically control airspeed via throttle management, prevents aircraft stall and ensures flight stabilization.
  
- f) **Integrated OSD with adjustable display** - OSD hardware is integrated into the module. Critical flight parameters are displayed via the video downlink. The display parameter outlay can be changed via RC control.
  
- g) **Power Manager Module** - FY-41AP is supplied with an integrated Power Manager and Current Sensor module. This module provides +5v power to the FY41AP, RC Receiver and +12V FPV video camera and transmitter. The current sensor sends battery voltage, Amp draw and power consumption data to the FY41AP integrated OSD.
  
- h) **Altitude control** - is achieved using a high sensitivity barometric sensor which measures relative height. Altitude is fixed via elevator servo control and throttle management.
  
- i) **Heading control** – is achieved by utilizing the three axis magnetometer, which senses the aircraft heading angle. Both the aileron & rudder servo is used to control flight heading. **GPS data** is used to automatically correct heading even in windy conditions.

## FY-41AP FLIGHT MODES



With GPS data input, the following are the FY41AP selectable flight modes:

- **Deactivated Mode** - In this mode, the FY-41AP auto stabilization is turned off. The aircraft is completely under pilot control.
- **Stabilized Mode** - level flight is automatically maintained, making flight simple, especially for beginners. If a pilot feels the plane is out of control, simply reduce input control and the plane will automatically recover level flight.
- **3D Mode** – if no input is given by the pilot (all sticks in the middle position), 3D mode will lock the current aircraft attitude. Therefore the aircraft can be easily maneuvered to complete a variety of 3D flight with added stability & smoothness.
- **Fixed altitude & Heading lock Mode** – this mode maintains aircraft flight course & holds the altitude on activation. By using GPS data, the system automatically corrects flight course deviation & maintains straight-line flight.
- **Auto Circling Mode** –On activation, the plane will maintain altitude and flight speed, while initiating a counterclockwise circle. The centre of the circle is the point of activation at a default radius of 80 meters (can be changed via FY GCS).
- **Waypoint Navigation Flight Mode** - enable you to fly fully autonomous, with up to 20 waypoint settings via the FY Ground Control Station (GCS) software.
- **Auto Return To Launch Mode (RTL)** – Upon activation of this Mode, the aircraft will automatically return to the Home point, maintaining its current altitude. Upon reaching the Home point, it will initiate auto circling.
- **GCS software** – By using a field computer and connecting the FY41AP to an FY Data Radio via the UART port, you can set the FY41AP flight parameters, monitor the flight progress & record / reply the flight via the FYGCS programme. For more information, please refer to the FY Data Radio manual.

### FY-41AP STANDARD CONFIGURATION

1	FY-41AP Control Module	
2	Power Management Module	
3	Airspeed Sensor	
4	RC receiver connecting wires	
5	USB cable	
6	GPS module	
7	4P Y cable	
8	Velcro tape and damper pads	

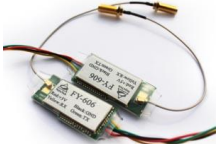
### Optional accessory

1	Data Radio	
2	Remote Adaptor	

## **FY41AP SPECIFICATION & WORKING REQUIREMENT**

Input voltage:	4.0 ~ 6.0 V
Current draw:	
Size:	
Weight (excluding wires) :	
Temperature range:	-25 ° C ~ +70°C
Maximum rate of rotation:	≤ 2000 °/s

### **GPS module**

Input voltage:	5 V
Current draw:	60mA (5V)
Size:	32 x32x 10 mm
Weight (excluding wires):	22g;
Temperature range:	-25 ° C ~ +70°C

### **The FY-41AP can be installed in the following aircraft**

- a) Normal / Traditional fixed-wing planes
- b) Delta-winged plane with rudder
- c) Delta-winged plane without rudder
- d) Plane without aileron
- e) V-tail plane with aileron
- f) V-tail plane without aileron
- g) Any other configuration please consult us: [service@feiyu-tech.com](mailto:service@feiyu-tech.com)

### **The FY-41AP has been tested to work with the following RC systems**

- Robbe-Futaba PPM / PCM 1024 / PCM G3 mode, 2.4 GHz systems ;
- Graupner/JR PPM 8, PPM 12, SPCM mode ;
- MPX PPM8, PPM 12 with UNI mode
- Any remote control system using the standard 1.5 ms neutral value.



### FY-41AP CONNECTION INTERFACE

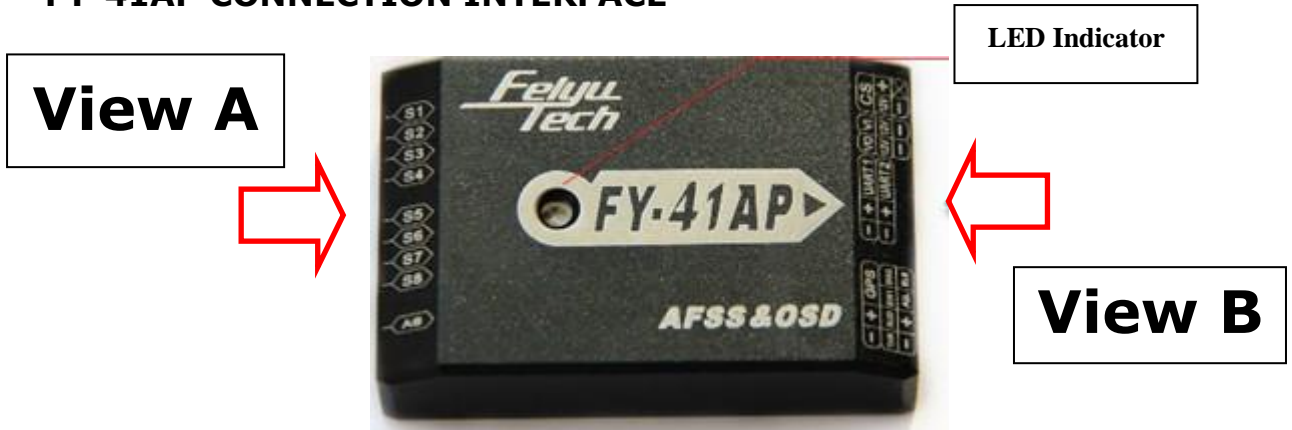

### VIEW A Interface diagram:

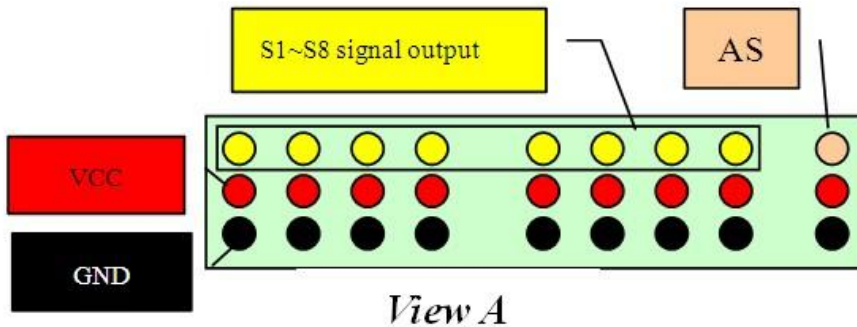

No.	S8	S7	S6	S5	S4	S3	S2	S1
Servo Output Interface	P2	P1	N	AIL2	RUD	THR	ELE	AIL
	Power +5V	Power +5V	Power +5V	Power +5V	Power +5V	Power +5V	Power +5V	Power +5V
	GND	GND	GND	GND	GND	GND	GND	GND

#### A) The Yellow pins S1 ~ S8 are signal output to aircraft servos.

- S1 : connect to Aileron servo 1 (same signal as S5).
- S2 : connect to Elevator servo.
- S3 : connect to ESC or engine throttle servo.
- S4 : connect to Rudder servo.
- S5 : connect to Aileron servo 2 (same signal as S1)
- S6 : not used for Airplanes

**S7** : When use Remote Adaptor, this pin outputs RC receiver CH7 (refer Remote Adaptor & Data Radio Manual)

**S8** : When use Remote Adaptor, this pin outputs RC receiver CH8 (refer Remote Adaptor & Data Radio Manual)

**B) The middle pins of View A are (+ve) power output to aircraft servos.**

**Important Note: Power is supplied from the RC Receiver.** The power Pins in **View A** is not connected to the Power supply Pins of **View B**. Do not short circuit the two sides.

**C) The bottom pins (black colour) are for GND (-ve).**

**D) AS – Airspeed Sensor** connection port. Please note signal, +ve and GND arrangement.

## VIEW B Interface Diagram

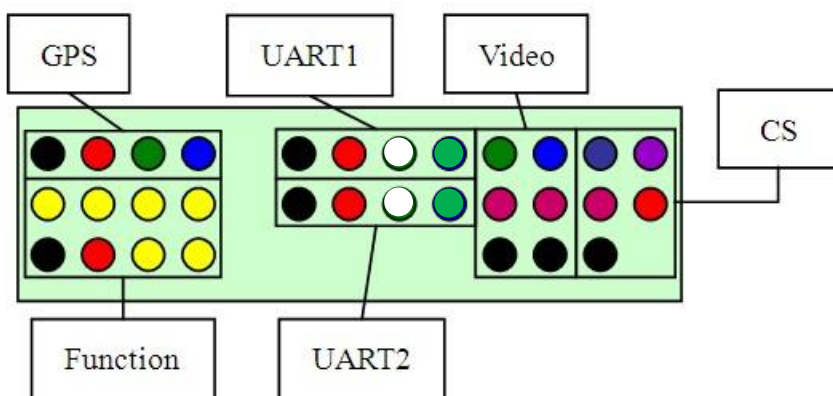

*View B*

a) **GPS pins** connection interface:

<b>GND</b>	<b>VCC</b>	<b>GPS-TXD</b>	<b>GPS-RXD</b>
------------	------------	----------------	----------------

**GPS-TXD:** Connect to GPS module RX port.

**GPS-RXD:** Connect to GPS module TX port.

**VCC:** +5V output port.

**GND:** GND output port.

b) **FUNCTION PINS** connection interface:

<b>SW1</b>	<b>RUD</b>	<b>THR</b>	<b>ELE</b>
<b>GND</b>	<b>VCC</b>	<b>AIL</b>	<b>SW2</b>

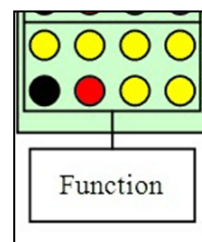

i) The Function Pins connect the FY41AP to your RC Receiver via the supplied plug and wires. Note the wires are colour coded:



Wire color	Receive channel	
<b>White</b> (bundled with red & black)	Aileron	Channel 1
<b>orange</b>	Elevator	Channel 2
<b>green</b>	Throttle	Channel 3
<b>yellow</b>	Rudder	Channel 4
<b>brown</b>	SW 1 - Any free channel controlled by a 3-way switch or dial knob	Channel 5
<b>blue</b>	SW 2 - Any free channel controlled by a 3-way switch or dial knob	Channel 6

- ii) **SW1** & **SW2**: Connect to your RC Receiver channels that will control the FY41AP flight modes.
- iii) **RUD**: Rudder RC Receiver port (Ch 4).
- iv) **THR**: Throttle RC Receiver port (CH 3)
- v) **ELE**: Elevator RC Receiver port (CH 2)
- vi) **AIL**: Aileron RC Receiver port (CH 1)
- vii) **VCC**: +5V power supplied from FY41AP to RC Receiver.
- viii) **GND**: Connected to RC Receiver GND (-ve).

### Connecting the FY41AP to the RC Receiver

- (1) FY-41AP requires a minimum of 6-channel RC receiver.
- (2) 4 Receiver channels are used for aileron (Ch 1), elevator (Ch 2), throttle (Ch 3) & rudder (Ch 4).
- (3) 2 free Receiver channels are required to control the FY-41AP Flight Modes via **SW1** & Navigation Mode via **SW2**.

c) **UART1** module interface:

<b>GND</b>	<b>VCC</b>	<b>UART1-TXD</b>	<b>UART1-RXD</b>
------------	------------	------------------	------------------

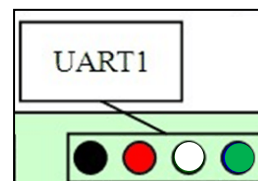

This port is used to:

- ❖ **Connect to your PC** via supplied USB cable to update the **FY41AP autopilot firmware**.
- ❖ **Connects to FY Data Radio** for communication via FY-GCS

- a) **UART1-TXD** : TX port.
- b) **UART1-RXD** : RX port.
- c) **VCC** : **+5V** output port to power Data Radio or input power via PC USB supply (during firmware upgrading).
- d) **GND** : **GND** output port.

d) **UART2** module interface:

<b>GND</b>	<b>VCC</b>	<b>UART2-TXD</b>	<b>UART2-RXD</b>
------------	------------	------------------	------------------

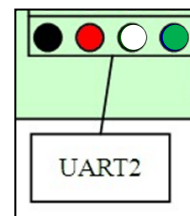

This port is used to:

- ❖ **Connect to your PC** via supplied USB cable to update the **FY41AP OSD firmware**.

- a) **UART2-TXD** : TX port.
- b) **UART2-RXD** : RX port.
- c) **VCC** : **+5V** input via USB supply (during firmware upgrading).
- d) **GND** : **GND** output port.

e) **Video Signal In/Out** interface:

<b>V-out</b>	<b>V-in</b>
<b>12V</b>	<b>12V</b>
<b>GND</b>	<b>GND</b>

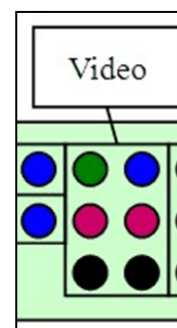

- V-out**: connect to video transmitter
- V-in**: connect to FPV Camera video output
- 12V**: 12 Volt output supply to video transmitter and camera  
(**make sure your equipment is rated 12 volts!**)
- GND**: connect to video transmitter or camera -ve.

e) **CS (Current Sensor)** interface:

<b>CS</b>	
<b>12V</b>	<b>VCC</b>
<b>GND</b>	

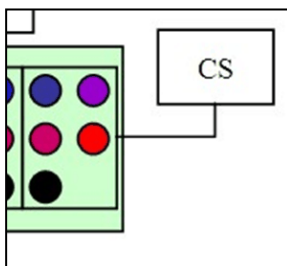

- CS** : Two pin interface for Current Sensor Data.
- 12V** : Provides + 12V power to FPV Camera and video Transmitter
- VCC** : Provide +5V power to FY41AP, RC Receiver, GPS Module & Data Radio
- GND** : Connect to Ground (-ve)

## PLANE SERVO CONNECTION (Refer VIEW A)

1) Connection for traditional Aileron/Elevator/Rudder airplane layout :

S1	S2	S3	S4	S5
Aileron servo 1	Elevator servo	ESC/throttle servo	Rudder servo	Aileron servo 2

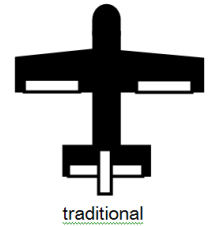

2) Connection for flying wing aircraft (with or without Rudder)

S1	S2	S3	S4
Differential Servo 1	Differential Servo 2	ESC/throttle servo	Rudder servo

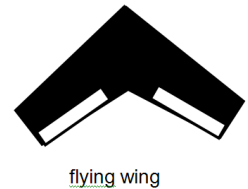

3) Connection for V tail aircraft with Aileron

S1	S2	S3	S4	S5
Aileron servo 1	Differential servo 1	ESC/throttle servo	Differential servo 2	Aileron servo 2

4) Connection for V-tail aircraft without Ailerons :

S1	S2	S3	S4
Differential Servo 1	Differential Servo 2	ESC/throttle servo	NULL



## INTEGRATED CURRENT SENSOR / POWER MANAGER

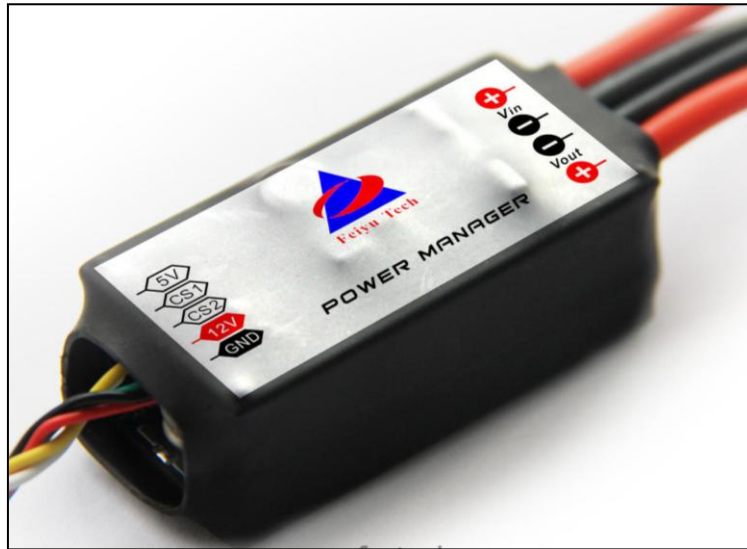

- a) The FY-41AP is supplied with a Power Manager that is both a current sensor & supply.
- b) The module outputs +5v to supply to the FY41AP and RC Receiver. It also supplies regulated +12v to power the video transmitter and FPV camera.

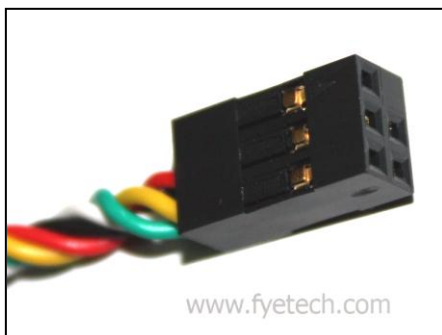

The 5-female plug from the Power Manager sends +5V to power the FY41AP & RC Receiver. It also powers your +12v FPV Camera and Video transmitter. The green & yellow plugs send current sensor data.

- c) We **DO NOT** recommend using the internal BEC of your ESC to power the FY41AP as this is unregulated power.

- d) **NOTE:** The Power Manager is **NOT** rated to supply power to the airplane servos. To power the servos, use your ESC BEC connected via **VIEW A** interface of the FY41AP. We highly recommend to use a +5v to +6v **External BEC (rated for 3A output)** plugged through **VIEW A** interface. **Remember to remove the red wire from your ESC plug if you use an External BEC.**
- e) For **Gas or Nitro powered planes**, you will require a +5 volt battery plugged into the RC Receiver. The connecting wire will send +5v power to the FY41AP (**Warning:** remove the +5v wire from the Power Manager plug if you use battery power).



## GPS INSTALLATION AND REQUIREMENTS

- a) Install the GPS Module on the airplane with the antenna face up:



- b) DO NOT install next to metal or carbon fiber & other shielding material, which may block satellite signal reception.
- c) Install the GPS Module away from electromagnetic sources such as ESC's, power wires, servo wires & video transmitters which can interfere with GPS signal.
- d) Wire interface:



Color	Black	Red	White
Function	GND	+5v	GPS Data

- e) Note that the FY41AP utilizes only the 5 volt version of the FY GPS Module.





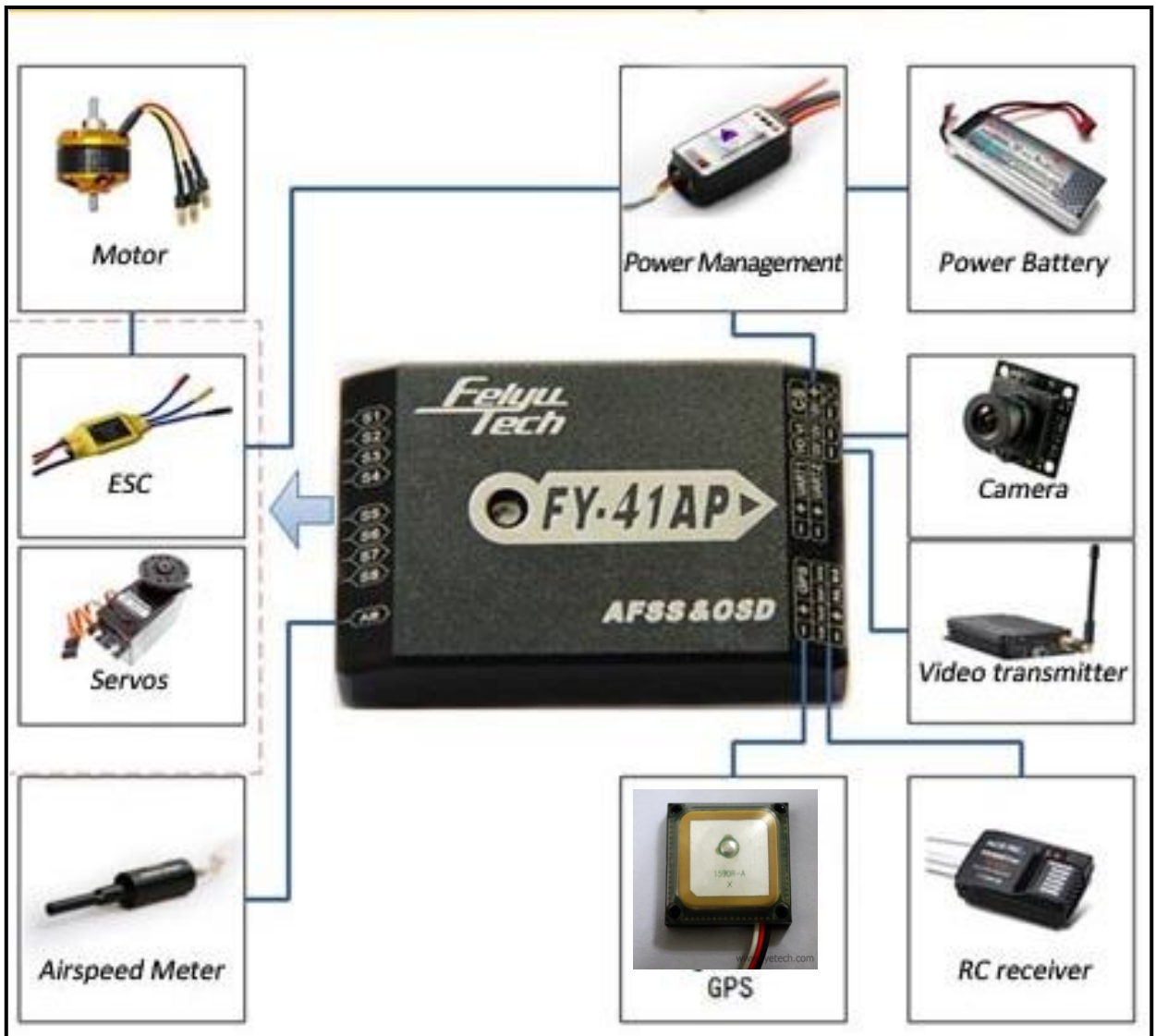















## FY41AP CONNECTION SUMMARY



## FY-41AP LED instruction

- FY-41AP outputs 3 LED colors to indicate flight modes: red, blue and green.
- It also outputs white for Gyro resetting.
- Examples of LED flashing indication:
  - green LED flash means GPS location has been fixed (>4 satellites)
  - Red & blue flashes working modes.
  - While static and in any flight mode the LED flashes purple light, this indicates the module needs a Gyro Reset.

Operating Mode	LED	Gyro Needs Reset or module senses movement	GPS lock (>4 Satellites)
Manual Mode			
Stabilized Mode			
3D Mode			
Return To Launch Mode			
Fixed Altitude & Heading Lock Flight Mode			
Preset Path & Waypoint Navigation Mode			
Auto Circling Mode			
During Gyro reset		 Flash white light for one second	
Too much vibration		 Red light Stay on solid	

## VIBRATION DAMPING

- a) FY-41AP is vibration-sensitive equipment. To optimize stabilization & autopilot function, vibration reaching the unit must be kept at minimum.
- b) When installing the module, we highly recommend that you use the supplied vibration absorbing pads as shown below.

These damper pads will greatly reduce vibration reaching the module and provides adequate damping for most electric & gas/nitro powered planes.



- c) The algorithm in the FY-41AP compensates for normal levels of flight vibration. However, if the vibration exceeds the acceptable level, stabilization will not work normally or may even stop working altogether.
- d) Install the FY-41AP away from the engine or any other vibration sources.
- e) **Balance your propeller to minimized on board vibration.**

## CHECKING FOR VIBRATION LEVELS

Even with the shock absorbing mount, your aircraft set up may not meet the vibration damping requirement.

To check for vibration level, please follow this procedure :

- Installing the entire system as recommended (ensure correct orientation).
- With the system fully operational, **carefully** run the plane engine or motor at different throttle levels. **DO NOT TAKE OFF**.
- **Increase** the motor throttle incrementally & maintain for 20 seconds at each position. Observe the state of the **Red** LED light. If it stays **OFF**, that means your vibration level is acceptable.
- If instead the red LED lights up bright & stays ON solid, then vibration is too high. You will need reduce the level of vibration on your aircraft. Add additional damping, change the FY41AP location or balance your engine / propellers to reduce vibration.

## IN-FLIGHT SYMPTOMS OF TOO MUCH VIBRATION

- In the stabilized mode, the plane cannot keep a steady attitude. It may suddenly roll or pitch or show other abnormal attitudes.
- Under the stabilized mode, after flying for a while, course direction and flight attitude changes erratically.
- All autonomous navigation modes (assisted by GPS) cannot function normally.

## SWITCH CHANNEL SETTING

a) FY-41AP needs two 3 way-switches to control its flight modes :

- SW1 is used to select either manual mode, stabilized mode & 3D mode.
- SW2 is used to set Auto Return To Launch Mode, Fixed altitude & Heading lock flight Mode & Auto Circling Mode.

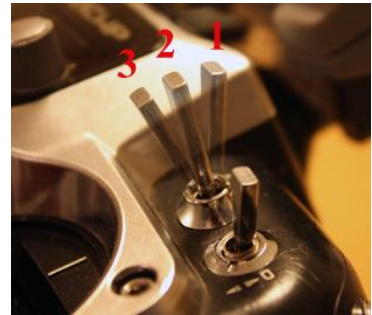

b) **SW2** function had priority over the **SW1**. Only when SW2 switch to cancel (Null) position can the SW1 switch work.

c) After programming your radio switches (SW1 and SW2), please observe the LED Flashes to confirm correct mode setting.

### SW1 DEFAULT SETTING STATE

POSITION	1	2	3
servo signal output	900 ~ 1200US	1200~1800US	1800~2100US
Function	Manual Mode	Stabilized Mode	3d Mode
LED	●	● ●	● ● ●

### SW2 DEFAULT SETTING STATE

Position	1	2	3
servo signal output	900 ~ 1200US	1200~1800US	1800~2100US
Function	fixed altitude & heading lock mode	NULL	Auto Return To Launch Mode
LED	● ●		●

Other function can be set to the SW2 via FY-41AP setting software.

## FY-41AP INSTALLATION ORIENTATION

- a) FY-41AP support 4 installation orientations (LOGO arrow to up, down left or right). **Default** installation orientation is logo up with arrow pointing forward (direction of flight) as shown below:

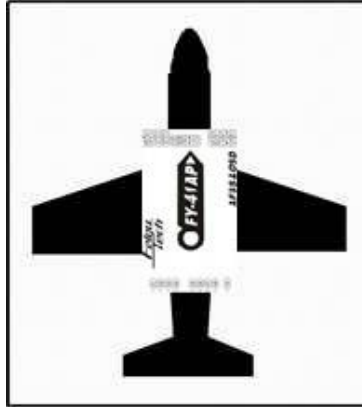

- b) If the default orientation is not possible, you can change the orientation setting via the FY-41AP software:

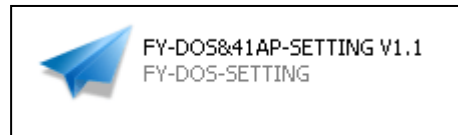

Select orientation, and confirm via 'Set' button.

## FY-41AP INSTALLATION POSITION

- When installing the FY41AP, please install it horizontal & as close as possible to the "Centre of gravity" (COG) of the aircraft.
- A module that is not installed horizontal can result in stabilization issues as below:

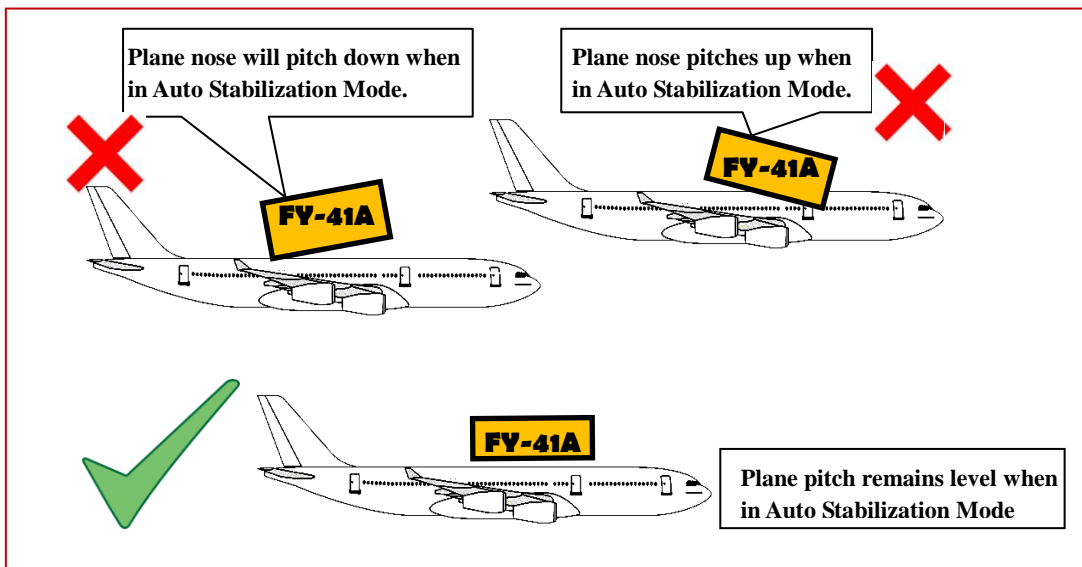
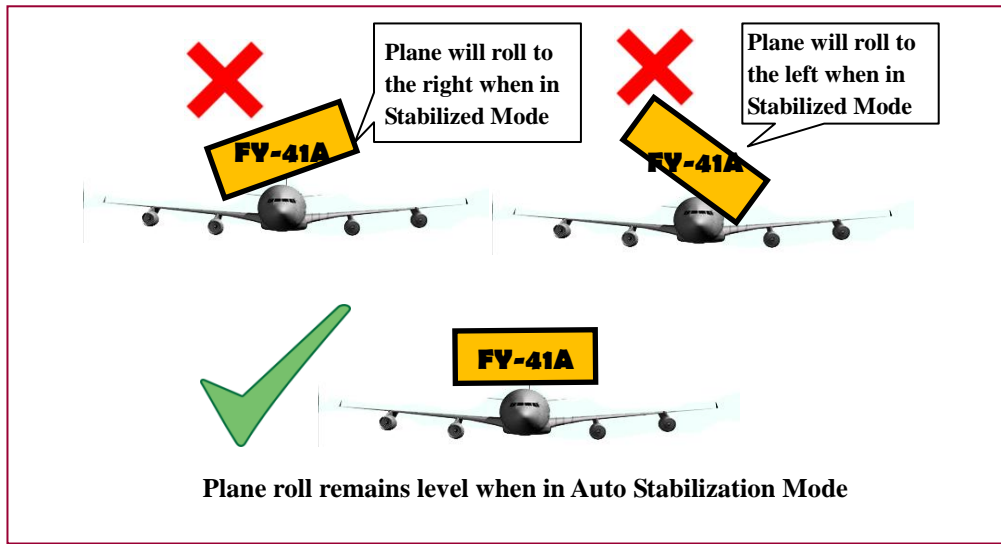

- However, minor flight deviation due to non-horizontal installation can be corrected with using your RC Transmitter trims.



## SETTING CORRECT SERVO DIRECTION

- After FY41AP, servos, RC Receiver & ESC / Motor installation, it is time to test the control surfaces movement and ESC function.
- Power up the system and check that the servo direction (ailerons, elevator, rudder, differential servo, ESC / Motor function, etc.) using your RC Transmitter.
- If the direction is not right, go to your radio transmitter menu and reverse the channel as done normally.

## AUTO BALANCE MODE (ABM) SERVO MOVEMENT CHECK & SETTING

- After the above is completed, it is time to check the automatic stabilized servo movement.
- Activate the Stabilized Mode via your RC Transmitter 3-Way switch (**SW1**).
- Observe Automated AILERON movement**

- Roll the plane as shown below and observe the servo movement:

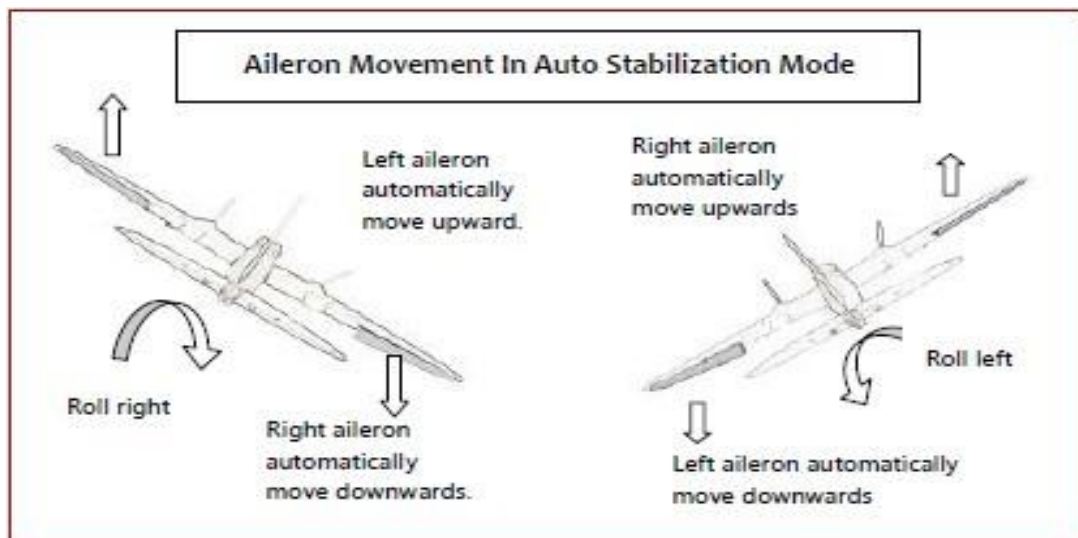

- RIGHT Roll the plane & the right aileron should automatically move downwards, while the left aileron moves up.
- LEFT Roll the plane & the left aileron should automatically move downwards, while the right aileron should move up.

- If the servo movement is incorrect, you need to reverse the automated servo movement via the FY41AP software setting. Refer '**Reversing Servo in Stabilized Mode**' in this Manual.

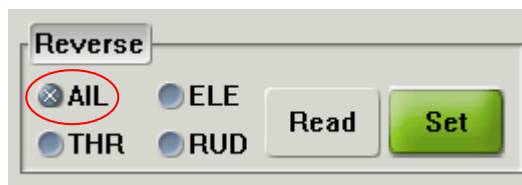

- Reversing the servo movement can also be done via your OSD downlink. **Refer Manual 22 Points.**

#### d) **Observe Automated ELEVATOR movement**

- Pitch the plane nose up & down as shown below:

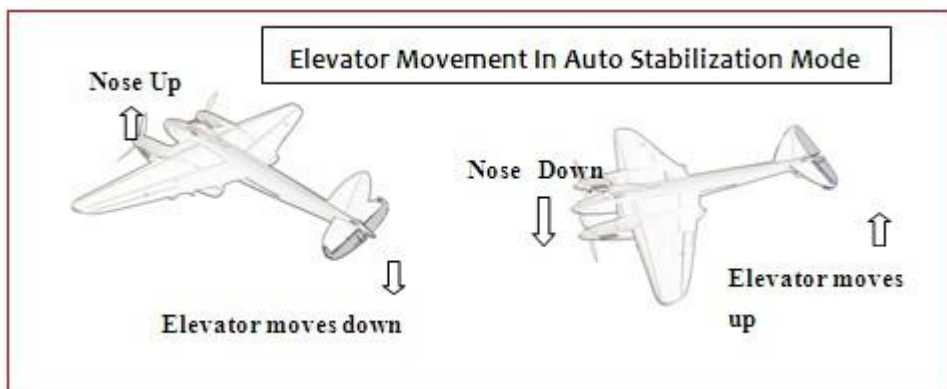

- UPWARD Incline the plane nose & the elevator should automatically move downwards.
- DOWNWARD incline the nose & elevator should automatically move upwards.
- If the servo movement is incorrect, reverse it via the setting software or OSD.



### e) **Observe Automated RUDDER movement**

- Rotate the plane as shown below:

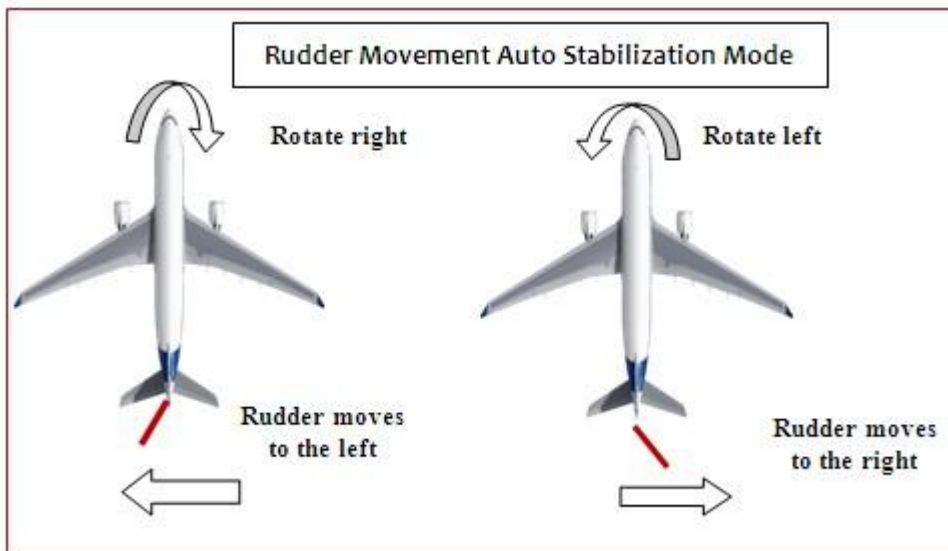

- CLOCKWISE rotate your plane & the rudder should move to the Left.
- COUNTER CLOCKWISE rotation & the rudder should move to the Right
- If the servo movement is incorrect, reverse via the setting software or OSD.

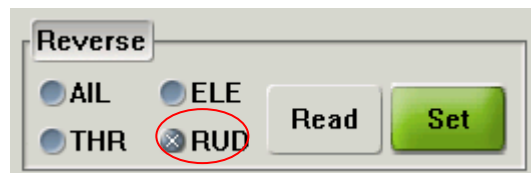

### f) **ESC/ THROTTLE CONTROL SURFACE MOVEMENT CHECK**

- Check that the throttle function is normal in Autobalance Mode.
- If the ECS / Motor does not activate normally, reverse the ESC signal output via setting software or OSD.



## GYROSCOPE RESET

Under the following conditions, resetting the FY-41AP gyros is recommended:

- (1) The device has not been used for a long time.
- (2) There is a change in environmental temperature of over 30 degrees since last flight.
- (3) The purple LED flashes continuously even when the FY-41AP remains stationary & motor not activated.

### Note :

- Carry out gyro reset only if the above occur. Regular resetting is not necessary & not recommended.
- The FY41AP Module does not need to be in a horizontal position during reset. However, you must ensure there is no vibration or movement during the process.

## INITIALIZATION / RESET PROCESS:

- (a) Power up the FY41AP & keep stationary.
- (b) Using your 3-Way switch, move between Deactivated Mode and Auto Balance Mode **6 times** over a period not longer than 3 seconds.

ABM → Deactivated Mode → ABM → Deactivated Mode → ABM → Deactivated Mode → ABM → Deactivated Mode → ABM → Deactivated Mode → ABM → Deactivated Mode.

- (c) Following above, the FY-41AP LED will flash white for one second.
- (d) After the white LED switches off, the gyro reset is complete.
- (e) Gyro Reset can also be done using the Setting Software, by pressing "**Init GYRO**" button. Similarly, make sure there is no movement during this Gyro initialization process:

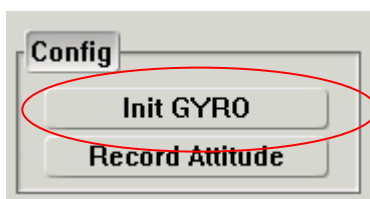

## FY-41AP SETTING SOFTWARE

- a) The Setting software is used to adjust the FY41AP parameters and module set-up in a simple and fast manner.
- b) Before conducting this procedure, please ensure you download the required software onto your computer:

(1) USB-TTL device driver. Download from FY website: [USB Driver](#)

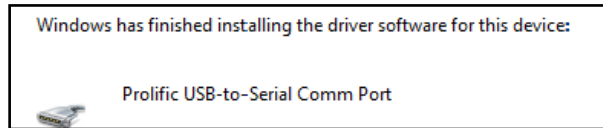

(2) Software Setting Download from FY website: [SETTING SOFTWARE](#)

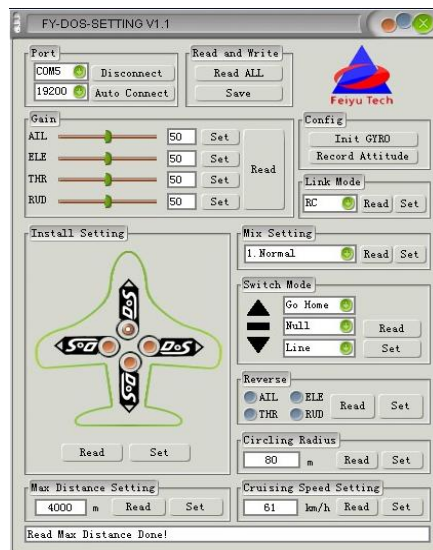

(3) Connect the FY41AP directly to your computer using the supplied USB cable, make sure you follow the USB Plug cable colour as shown below:

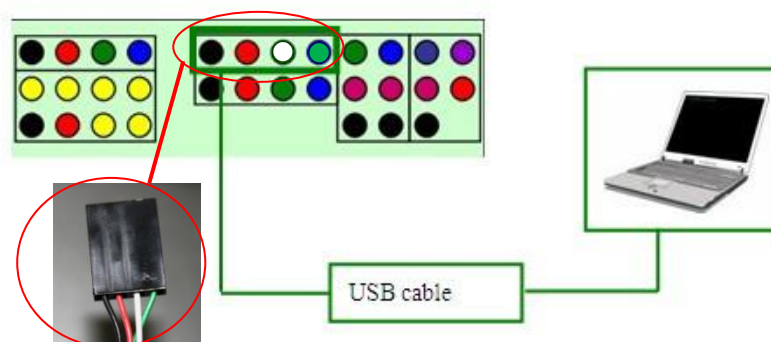

- (4) If you are powering the FY41AP via your battery pack **please make sure you remove the Red Wire from the USB TTL Plug**, as shown below:

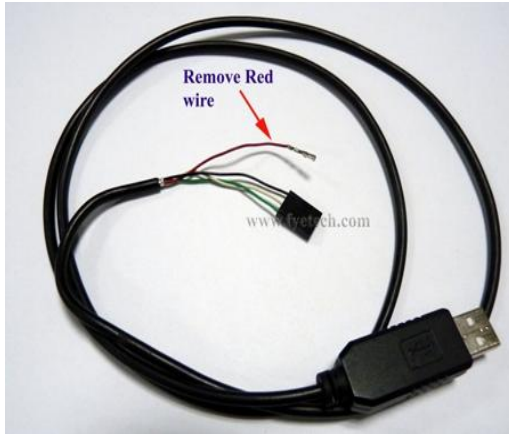

**Remove Red** wire if using the FY41AP on board power. Failure to do this may result in damage of your PC and FY41AP.

- (5) After plugging in the USB TTL Cable, find the COM port number:

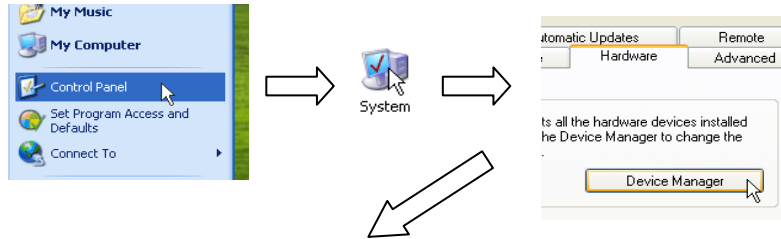

Check the COM Port number for Prolific

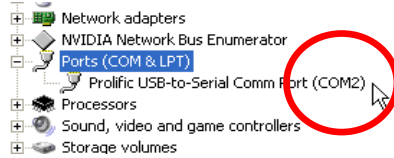

- (6) Open the setting software:



- (7) Select the COM Port number. Ensure the Baud rate is '19200' as shown below. Press 'Connect' or 'Auto Connect'. The 'Connect' button will change to 'Disconnect' upon successful connection:

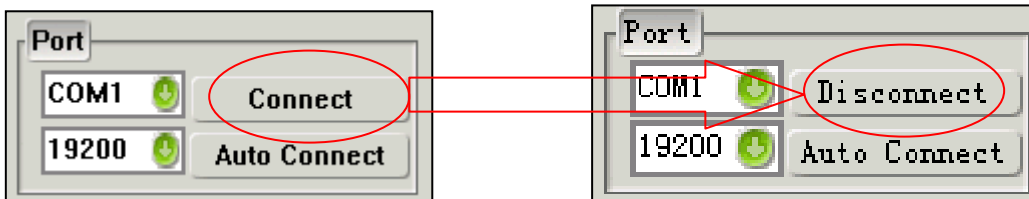

(8) Press the 'Read ALL' button:

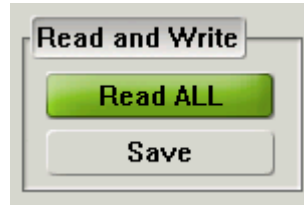

(9) After making your setting changes, remember to press the '**Save**' button to update the FY41AP flash memory.

(10) **CHANGING STABILIZATION GAIN:**

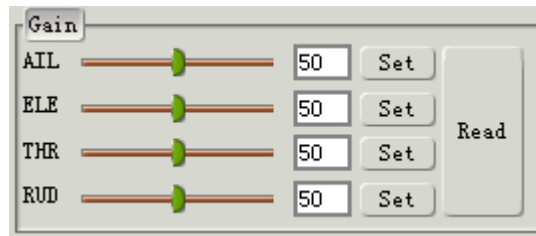

- Each channel (Aileron, Elevator, Throttle, Rudder) gain can be adjusted individually.
- Gain controls the sensitivity of Auto Stabilization, with a range of '0' (zero) for no stabilization, to '100' for maximum stabilization.
- Note that **too low gain** results in poor auto stabilization, **too high gain** will cause oscillations of the aircraft.
- Adjust your aircraft gain setting from the lowest gain and increase it until stabilization is optimum. **Never carry out your first test flight at maximum gain.** Aircraft oscillations can lead to crash.
- Remember to press the '**Set**' button to save your updated gain setting.

(11) **CONFIGURATION FUNCTION:**

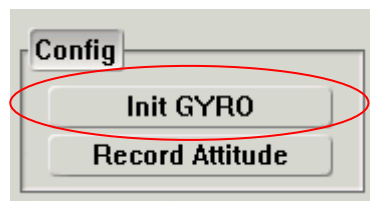

### Init GYRO

- Use the '**Config**' function for gyro re-set / initialization.
- During gyro re-set don't move the FY41AP.

- The software prompts Initialization Success upon complete gyro reset.
- **WARNING: Do Not** press this Init GYRO button during flight!

### Record Attitude :

- This function is used to eliminate any installation deviation from the default '0' (zero) horizontal angle. A non horizontal level can cause Auto Balance Mode flight deviation (Refer *FY-41AP INSTALLATION POSITION* in this manual).

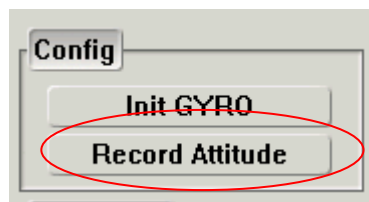

- There are two methods to Record horizontal Attitude.
- **Method 1 (Basic Method):**
  - (i) Place your plane on a table, and manually adjust the plane position so that it is **perfectly level**.
  - (ii) Connect the FY41AP to your PC (USB red wire removed).
  - (iii) Power up the FY41AP.
  - (iv) Connect to Setting Software.
  - (v) Activate Auto Balance Mode (ABM), check that all control surface are at neutral. If not, adjust via the servo links.
  - (vi) Press **Record Attitude**. The FY41AP have now recorded your aircraft horizontal position.
- **Method 2 (Accurate Method)**
  - (i) In this method, you will need to connect your FY41AP to your field computer via the FY Data Radio (e.g. FY606).
  - (ii) Link the Setting Software to the FY41AP via the Data Radios.
  - (iii) Fly your plane in ABM and adjust trims until the plane flies perfectly balanced.
  - (iv) Press **Record Attitude**. The FY41AP records your aircraft attitude for perfectly level flight.



## (12) 'LINK MODE' SETTING

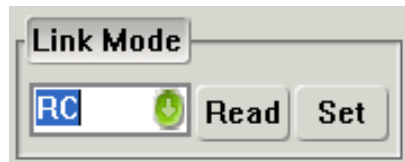

- (i) Link mode sets the FY41AP to be flown by either RC control or by FY Data Radio control. 'RC' is the default Link Mode setting.
- (ii) If you are using an FY Data Radio and Remote Adapter to fly your airplane, choose "RADIO" instead and press 'Set' (for details, please see Remote Adaptor & Data Radio manual):

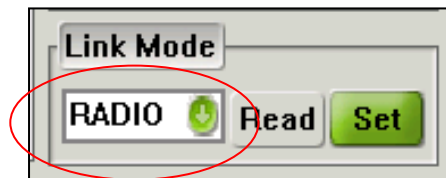

## (13) INSTALL SETTING



- FY-41AP supports four installation direction. **However, the LOGO must be installed facing up.**
- FY-41AP has an arrow printed on the top of it. Normally, this arrow points towards the front (direction of flight).
- If you install the module in any other direction than default forward, you need to set the module direction via the Install Setting option.
- **Warning:** Failure to correctly set the Install Setting direction will result in Auto Balance malfunction.

(14) **MIX SETTING**



(i) Selects aircraft configuration. Supports configurations as listed:

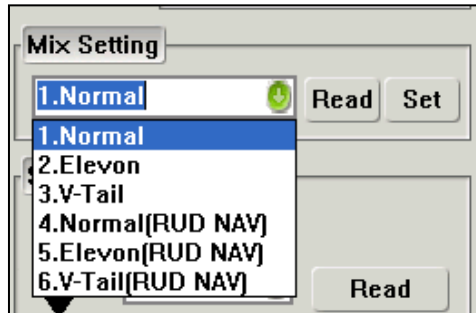

(ii) **NOTE:** Your RC Radio transmitter **MUST** select traditional airplane configuration with **No Mixing** in any of the channels.

If any channel is mixed the FY41AP cannot function normally.



(iii) Models selection table :

<b>Aircraft Config:</b>	<b>Mix Setting Selection</b>	<b>Remark</b>
Traditional aircraft layout with Aileron	1.Normal	Navigation control using aileron.
	4. Normal (RUD NAV)	Navigation control using rudder.
Flying wing aircraft	2.Elevons	Navigation control using aileron. Used for most kinds of flying wing planes.
	5.Elevons (RUD NAV)	Used for flying wings with independent rudder for Navigation.
V-Tail aircraft with Aileron	3.V-Tail	V-Tail with navigation via aileron.

	6.V-Tail (RUD NAV)	V-tail planes with independent Rudder for navigation control.
Traditional aircraft layout with no Aileron	1. Normal	The rudder servo must be connected to FY-41AP aileron servo output (AIL)
V-tail without aileron	2. Elevons	V-tail servo has to connect to FY41AP Differential Servo 1 & 2 output.
Airship	4.Normal (RUD NAV)	Due different airship configurations, use with caution. Carry out test flights to confirm normal function.

(15) 'SWITCH MODE' SW-2 FUNCTION SETTING

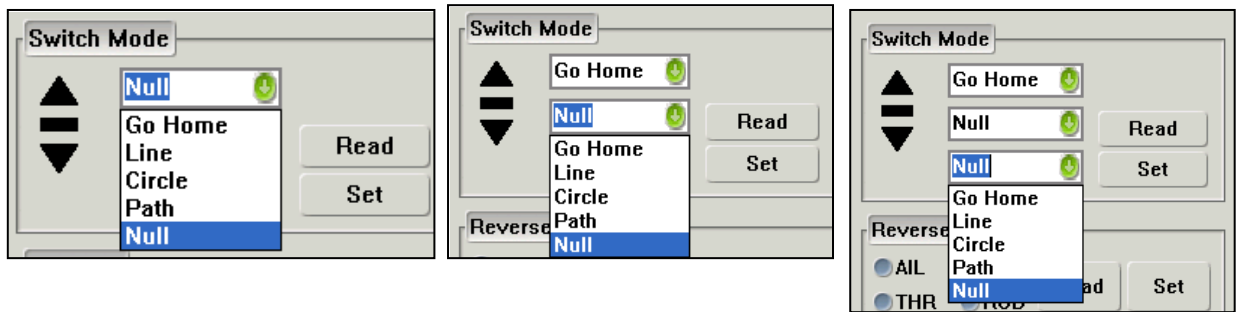

- (i) The Switch Mode setting allows you to select the function of each 3-Way switch position that controls the SW-2 channel.
- (ii) **NOTE:** SW-2 has priority over SW-1. Only when **SW-2** is in the 'Null' Mode can **SW-1** work. Therefore 'Null' should be one of the options for **SW-2**, otherwise **SW-1 will not work**.
- (iii) For the other two SW-2 switch positions, you can select any of the following Navigation functions:

SW2 Mode	Function	Remark
Null	SW-2 Deactivated	SW-2 set to NULL, Flying mode is controlled by SW-1.
Go Home	Auto Return To Launch	On activation, plane will automatically return to launch (RTL) point.
Line	Fixed altitude & Heading lock flight Mode	With no controlling input from the pilot, the plane will automatically lock current heading & maintain altitude.
Circle	Auto Circling Mode (ACM)	Automatically fly, circling a fixed point.

		Centre is at point of ACM activation.
Path	Preset Path & Point Navigation Flight Mode	Airplane will fly autonomous, following waypoints set via FY-GCS. Requires FY-Data Radio to save Waypoint to FY41AP module.

### (16) Reverse - Reversing Servo in Stabilized Mode

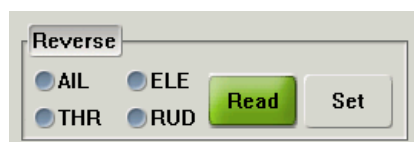

- (i) If in ABM, the automatic servo action is incorrect (reversed), use this to reverse the servo direction.
- (ii) You can reverse the automatic (ABM) stabilized servo direction for any of the listed channels (AIL, ELE, THR, RUD).
- (iii) Press 'Set' to confirm and save the direction reversal.
- (iv) Check that the direction has been corrected after disconnecting the FY41AP from the PC.

### (17) Circling Radius Setting

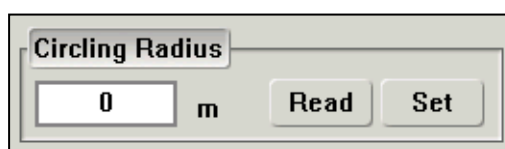

- (i) The FY41AP can fly over a set GPS point upon activation of Auto Circling Mode via switch SW-2.
- (ii) The default circling radius is 80 meters.
- (iii) You may adjust this circling radius using this Setting Software function. Press 'Set' to confirm and save your updated circling radius.

### (18) DIALOG BOX

- (i) A dialog box is located at the bottom of the Setting Software.
- (ii) This dialog box confirms any setting updates carried out by you.



## MAX DISTANCE SETTING

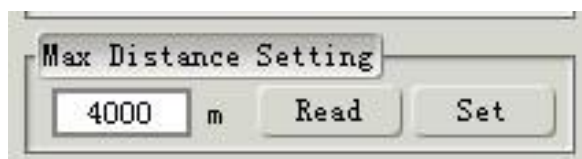

- (i) The FY41AP allows you to set the maximum distance allowed for your aircraft to fly from launch point.
- (ii) This max distance setting works regardless what flight mode the FY41AP is.
- (iii) Upon reaching the Max Distance setting, the aircraft will automatically engage autonomous Return to Launch (RTL).
- (iv) Therefore even if the FY41AP is in RC Mode (ABM and Autopilot deactivated), when the model reaches the maximum distance setting it will automatically RTL.
- (v) This feature of the FY41AP provides an additional aircraft 'Failsafe' even when the RC Receiver has no failsafe feature.
- (vi) The default Max Distance for the FY-41AP is 4000 meters. You can reduce and increase this as you see fit.

## (19) CRUISING SPEED SETTING

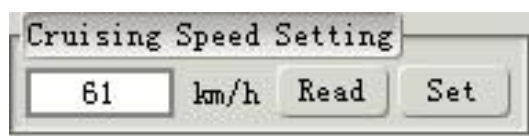

- (i) During **Navigation Mode** (autonomous flight) the FY-41AP will control its cruising speed via throttle control. This speed follows the Cruising Speed Setting.
- (ii) By default, the Cruising Speed Setting is 61 km/h.
- (iii) You can adjust this cruising speed as per your model's requirement. Fly the plane in at speeds most comfortable for cruising and Set that value via the Setting Software.

## AIR SPEED SENSOR

- (1) **Installation** - Connect the Airspeed Sensor to the FY-41AP - '**AS**' Port (see **VIEW A**).



- (2) Install the sensor with at least 1 cm of the tube exposed to the outside air. Ensure airflow is clear in front of the sensor.

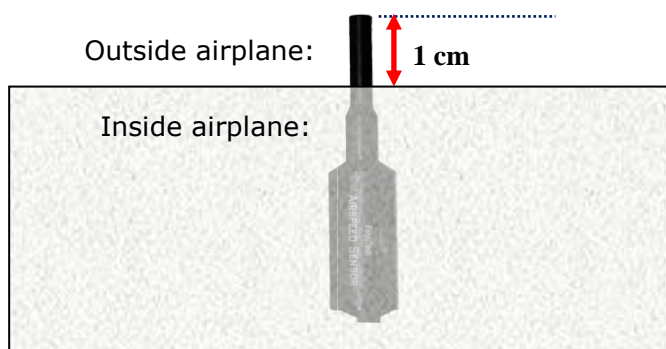

If your airplane has propeller in front, please install the sensor away from the propeller airflow. This is to avoid wrong airspeed detection.

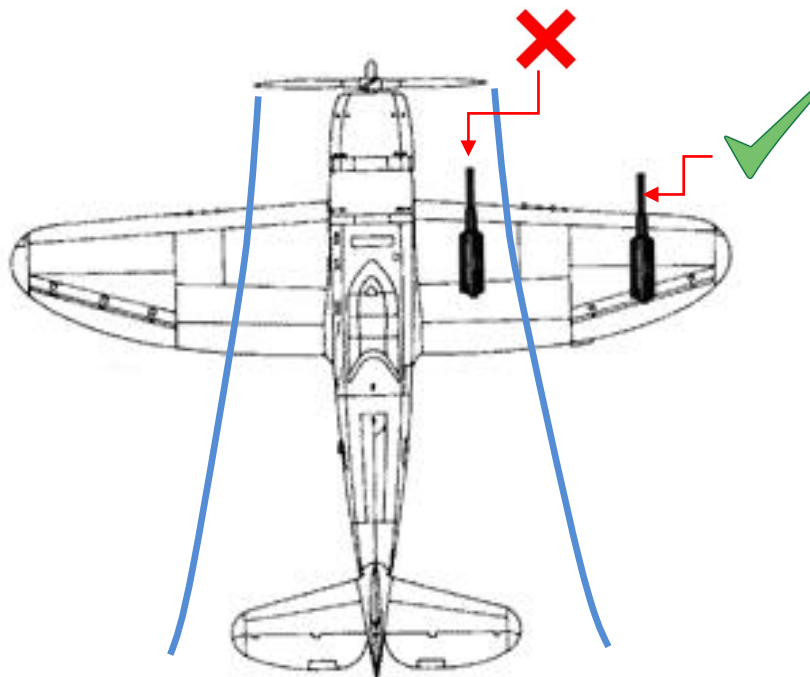

- (3) **Airspeed defined:** The sensor measures 'Dynamic Pressure' which is the air pressure entering the tube. This dynamic pressure is compared to the FY-41AP internal barometric 'static pressure' (ambient pressure). The difference between the two pressure data is calculated to provide an accurate aircraft airspeed.
  
- (4) Airspeed sensor enables constant cruising speed control particularly in Navigation (fully autonomous) flight. Cruising speed is set via the Setting Software.
  
- (5) Upon plugging the Airspeed Sensor onto the FY41AP, the OSD will display Airspeed. If the Airspeed Sensor is removed, the FY41AP will automatically display GPS speed.

## **FY-41AP FIRST FLIGHT TEST CHECKLIST**

- 1) Before your first flight, please reconfirm that the FY41AP have been installed as recommended by this manual. Further ensure vibration is at acceptable level (check Red LED).
- 2) Check the FY-41AP installation (arrow) direction.
- 3) Power up the system and confirm SW-1 & SW-2 switches are correctly set via the LED flashing and colour.
- 4) Switch the FY-41AP to Auto Stabilized Mode (ABM) and confirm the automated control surfaces direction is correct. Make sure GAIN is not set too high (will result in oscillation).
- 5) Confirm the gyro is working properly: place plane **stationary** and SW-2 is in Deactivated Mode (Null). Proceed with flight test if there is no purple LED flashing.
- 6) After completing the above basic check, you can take off in either manual mode or ABM.
- 7) If required, adjust your transmitter trims until the plane fly level.
- 8) Add plane roll & pitch input and observe the rate of automatic balance action. If recovery to level flight is too quick (flight control feels sluggish) then gain may be too high. Land and adjust Gain according to the channel involved (AIL, ELE or RUDD).
- 9) If the aircraft shows rapid oscillation during ABM, this means Gain is extremely high. Quickly land the plane and reduce gain accordingly.
- 10) If recovery to level flight is too slow, that means Gain is too low. Land and increase gain accordingly.
- 11) To test the RTL function, fly in ABM at cruising speed to a comfortable distance. Switch (SW-2) to RTL Mode. The plane should turn & fly towards home. Upon reaching home point, it will automatically circle above. If the test is successful, you may switch back to ABM and fly further out to test the RTL again.



## DATA RADIO & GCS SOFTWARE

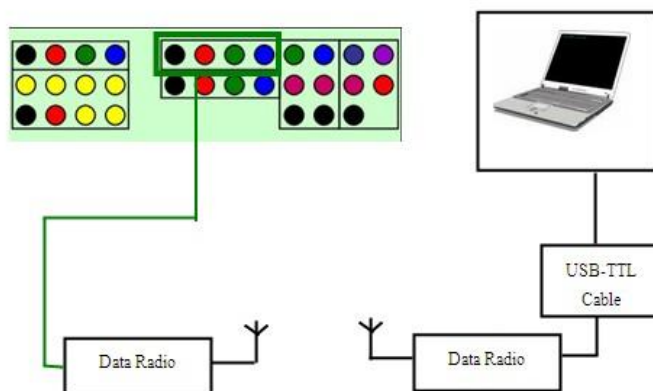

- (i) Refer to the FY-Data Radio and FY-GCS Manuals for more details.
- (ii) Three data radio options are available:

### FY606 2.4 Ghz 100mWatt:

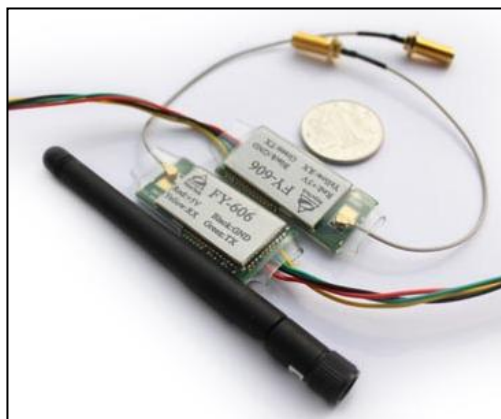

### : FY602 433 mHz 500mWatt

### FY605 433 mHz 2000mWatt:



- (iii) By connecting the FY-41AP to your field computer via Data Radio, you can monitor flight parameters including flight altitude, speed, flight path, flight progress via the FY-GCS software, etc.
- (iv) Various FY-GCS software can be downloaded from the FY website ([www.feiyudz.cn](http://www.feiyudz.cn)). The GCS version used depends on the processing capacity of your field computer:

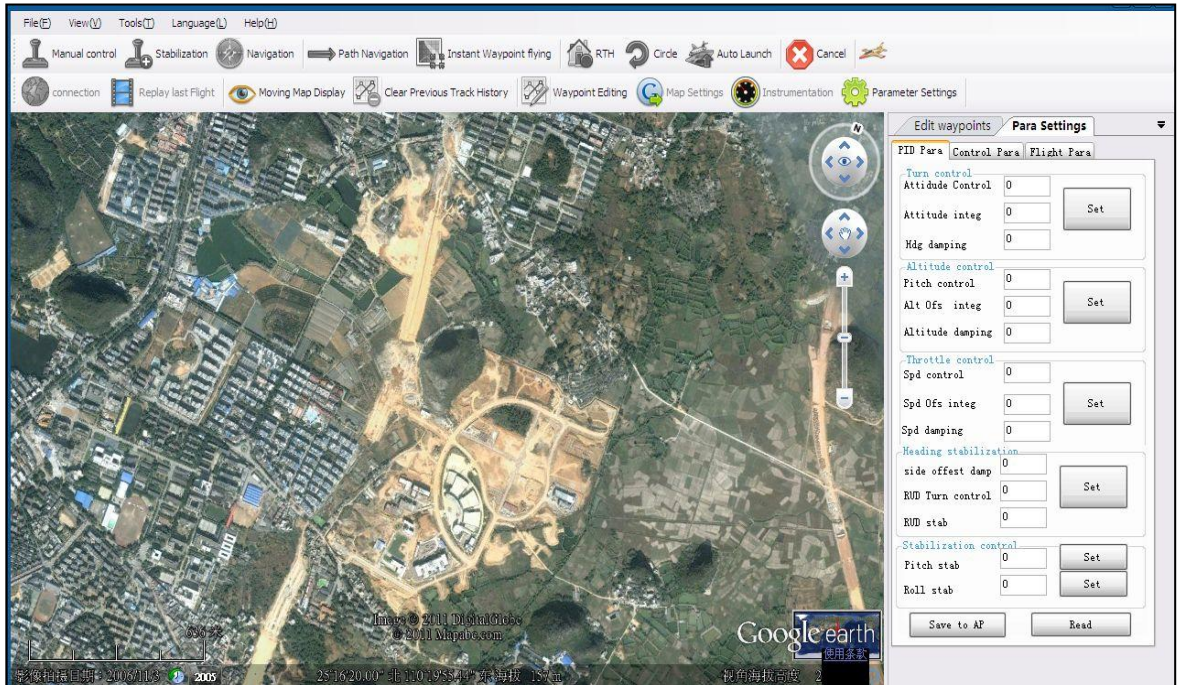

- (v) **Remote Adapter** – allows you to fly the aircraft with only the FY41AP and Data Radio on-board.



## **WARNING:**

### **PILOT INPUT AND AUTONOMOUS FLIGHT INTERACTION**

- a) This paragraph explains the interactions between pilot input, Auto Balance Mode (ABM) and autonomous flight (Navigation Mode).
- b) In ABM, the FY41AP will constantly want to keep the aircraft flying level and straight. Any pilot input will go against this stabilizing action, in order for you to change the course, altitude or angle as you fly the plane.
- c) The higher the Gain setting AIL, ELE & RUD, the more you will feel the aircraft fly 'less flexible'. This is normal. The higher the Gain, the **stronger** will be the leveling action of the FY41AP. And the smaller the RC input you have on the aircraft.  
To counter this, reduce the Gain until you feel the plane's flying attitude is comfortable for your flying style.
- d) Alternately, if the Gain setting is too low, the aircraft self leveling will be weak and the greater the pilot manual control will be.
- e) In Navigation Mode (Auto Return To Launch-RTL, Auto Circling Mode-ACM, etc.) the plane is flying fully autonomous. To ensure that pilot input does not confuse this autonomous function, during Navigation Mode, let go of the RC control sticks (middle position). Failure to do so will interfere with the autonomous flight system which can lead to control loss and crash.**

## **FAIL-SAFE AND AUTONOMOUS RETURN TO LAUCH**

- a) If your RC Receiver / Transmitter has Fail Safe function, please use it. To ensure your plane returns to you in case of transmission failure, etc., carry out the following **Fail Safe Settings**:
- (1) Set **SW-2** to go into RTL mode.
  - (2) Set throttle failsafe at your plane's cruising speed position.
- b) If you are flying via FY-Data Radio and Remote Adapter (refer Data Radio manual), if the system detects any Data Radio communication interruption of longer than 5 seconds, the FY41AP will automatically activate RTL. Therefore no 'Failsafe' setting is required when flying in this configuration.
- c) **MAX DISTANCE SETTING:**
- (1) The FY41AP has a Maximum Distance Setting function, which you can adjust via the Setting Software.
  - (2) The Max Distance Setting **will not allow** the plane to fly beyond the distance you have set. Upon reaching this distance, the FY41AP will automatically engage RTL and fly back to you.
  - (3) The default Max Distance Setting programmed into the FY41AP is 4000 meters.
  - (4) This function adds a second level of 'Fail Safe' for your plane with FY41AP on board. This will ensure your plane will not 'fly away' in case of RC failure or pilot error.

## FY-41AP-OSD INSTRUCTIONS

- (i) The FY41AP has an integrated OSD video overlay hardware built into the system.
- (ii) This allows the FY-41AP to display critical flight telemetry information onto your existing video downlink without the need for an external OSD Module.
- (iii) The FY-41AP-OSD can adapt to both PAL & NTSC video signal.

## WORKING PROCEDURE

- (i) After power ON, the OSD will immediately activate.
- (ii) If there is no video input, the OSD will only display the FY LOGO and wait for the incoming video input.
- (iii) After the video stream is transmitted, even when there is a break in camera video signal output, the FY-41AP OSD will continue transmitting telemetry information via the video transmitter.

## FLIGHT MODE ABBREVIATION

<b>Flight Mode Abbreviation</b>	<b>Introduction</b>
RC	Manual Flight. Autopilot deactivated.
3D	3D Mode
ABM	Auto balance mode
NAV	Preset Path & Point Navigation Flight Mode
RTL	Auto Return to Launch Mode
ADH	Fixed altitude & Heading lock flight Mode
ACM	Auto Circling Mode

## FY-41AP-OSD DISPLAY INTERFACE

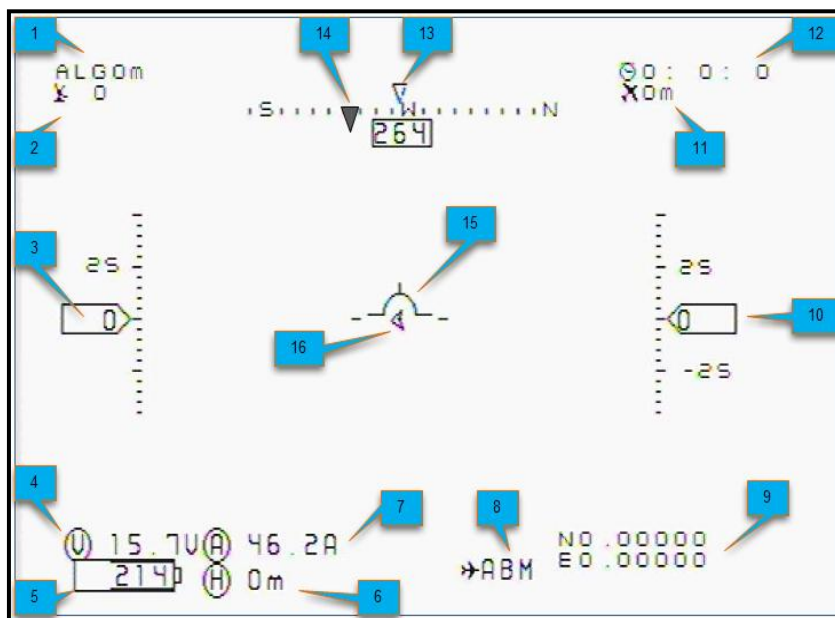

No.	Instruction
1	GPS altitude(Unit: m)
2	The quantity of satellite used for positioning
3	GPS speed (Unit : km/h)
4	The battery voltage of the videotransmitter (Unit: V)
5	Battery power consumed (Unit : mA/h)
6	Distance to Home Point (Unit : m)
7	Power battery current (Unit : A)
8	Flight mode
9	Current latitude & longitude of the plane (Format: dddmm.mmm)
10	Relative altitude (Unit : m)
11	Flight total mileage (Unit : km)
12	Total flight time (Format:h:m:s)
13	Current course of flight (Unit : deg)
14	The angle of turning to the Home Point (Unit : deg)
15	Attitude table
16	Relative position of Home Point (Icon in the middle position when the aircraft is around Home Point.)

## ADJUSTING FY41AP SETTING VIA OSD

- (1) You can enter the Flight Setting of the FY41AP via the OSD Menu.
- (2) You can activate Setting-Via-OSD by switching between ABM and 3D Mode using SW-1.
- (3) This mode switch must be carried out 6 times within 3 seconds as follows: ABM → 3DMode → ABM → 3DMode → ABM → 3DMode → ABM → 3DMode → ABM → 3D Mode → ABM → 3D Mode
- (4) The Setting-Via-OSD screen looks like this:

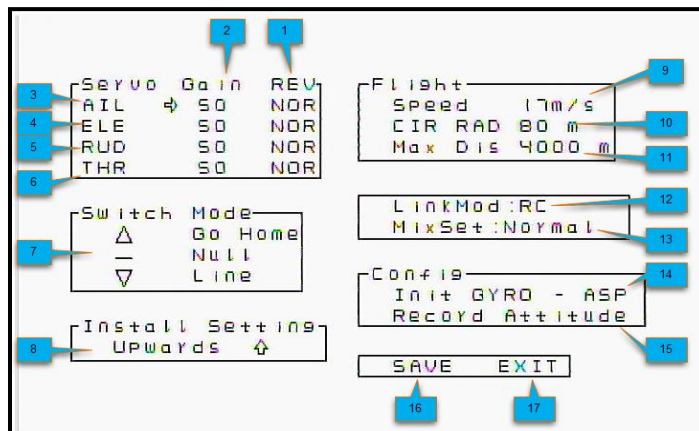

- (5) Once the Setting-Via-OSD display is called up on your video screen, you can move the cursor using your **Elevator stick**.
- (6) Carry out the required adjustment value via the **Aileron stick** (e.g. increase or decrease the gain, servo reversing, 3-position-switch arrangement, etc.).
- (7) After completing the adjustment, move the cursor using the Elevator stick to the '**Save**' position, and use the Aileron stick to save the settings.
- (8) During the 'Save' procedure, the 'Save' icon will flash for two seconds indicating a successful setting update.
- (9) **Note that changed parameters will be effective only after the 'Save' procedure is successful.**

## OSD MENU INTERFACE

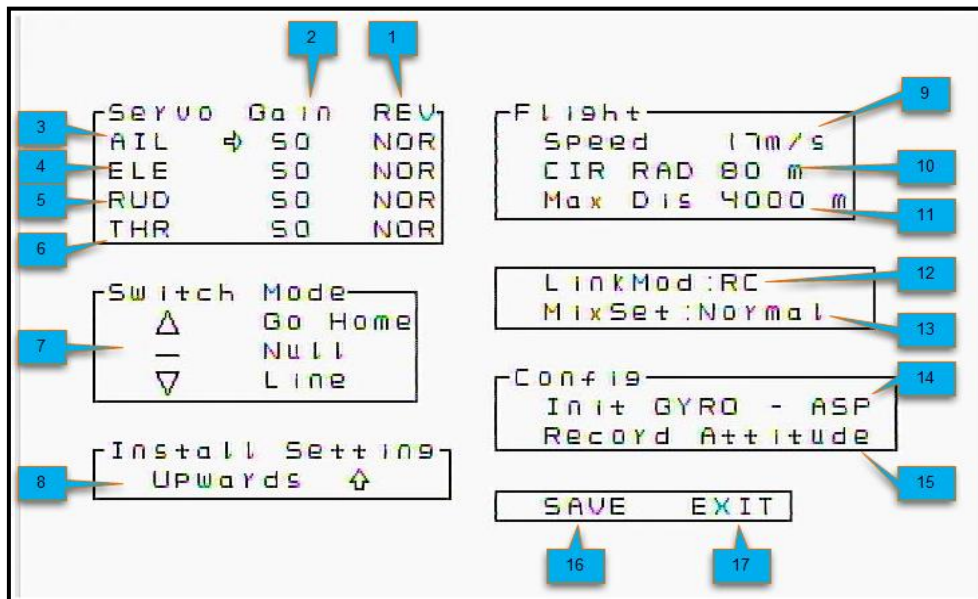

## MENU INTERFACE INSTRUCTIONS

1	Servo Reverse (NOR/REV)
2	Gain (0~255)
3	Aileron
4	Elevator
5	Throttle
6	Rudder
7	3-position-switch mode
8	Install Setting
9	Flight Speed (Unit: m/s)
10	Flight radius (Unit: m)
11	maximum distance (Unit: m)
12	Link mode
13	Mix set
14	Initialize Gyro & Airspeed meter
15	Record Attitude
16	Save
17	Exit

Note: We reserve the right to change this manual at any time! And the newest edition will be shown on our website.

-----END-----